

ALUMINIJSKE VODILICE SA ŠPAGOM I VODILICE NA ELEKTRO-POGON



ALU. VODILICE SA
ŠPAGOM I VOD. NA
ELEKTRO - POGON
AV 06.01 - 06.11



...jer o tome mnogo ovisi...
SCHWOLLER-L U Č I Ć

AL 1400

AV 06.01

- **alumijska vodilica sa mehanizmom za potezanje (sa debelom špagom za potezanje)**
- **za vrlo teške dekore i zavjese**
- **idealno rješenje za vrlo široke otvore**



...jer o tome mnogo ovisi...

SCHWOLLER-L U Č I Ć

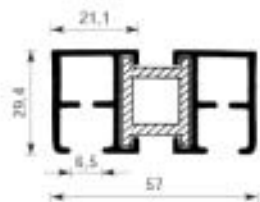

Primjena: aluminijska vodilica sa mehanizmom za potezanje (debela špaga), za stropnu montažu na sve vrste stropova, praktično rješenje za visoke zavjese i dekore, mogućnost naručivanja špage za potezanje u željenoj dužini, za teške dekore i zavjese, za široke otvore

Standardne boje: alu eloksirana, bijela

Napomena: komplet standardno dolazi s dva profila!

Molimo vas da prilikom naručivanja navedete visinu zavjese, položaj mehanizma (lijevo, desno) i dužinu špage za potezanje

Montaža: na strop - 1 vod.

sa špagom za potezanje

Pribor: klizač s kotačićem AL7472
metalna kvačica AL2513
završni čep AL0483
klizač za špagu AL1406
špaga AL2104
završne kape AL1405
stropni nosač AL1408K
vijci Z224 i tiple Z53

Dužina [cm]	Broj klizača s kotačićem AL7472	Broj vijaka i stropnih nosača AL1408K
300	30	6
320	32	8
340	34	8
360	36	8
380	38	8
400	40	8
420	42	10
440	44	10
460	46	10
480	48	10
500	50	10
520	52	12
540	54	12
560	56	12
580	58	12
600	60	12
620	62	14
640	64	14
660	66	14
680	68	14
700	70	14
720	72	16
740	74	16
760	76	16
780	78	16
800	80	16

svakih slijedećih 20 cm

CJENIK VODILICE AL 1400 POD KUTEM ILI SAVIJENE

Prilikom naručivanja potrebno je priložiti i skicu ili šablonu!!

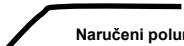
	Opis artikla	Šifra artikla
	Krovna kosina	AL5004













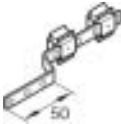

Naručeni polumjer

	Opis artikla	Šifra artikla
	Krovna kosina 90 °	AL5006

Radius 25 cm



Komponente za aluminijsku vodilicu AL1400

Opis artikla	Šifra artikla	Jed.mj.	Opis artikla	Šifra artikla	Jed.mj.
Vodilica AL1400	alu AL1400	met.	Klizač za špagu	AL1406	kom.
	bijela AL1400	met.			
U KOMADU (6 met.)	maksimalna dužina vodilice - 6 met.				
Vodilica AL1400	alu AL1400A	met.	Mehanizam za potezanje	AL7811	kom.
	bijela AL1400A	met.			
REZANA	maksimalna dužina vodilice - 6 met.				
Klizač za kotačićem	sivi AL7472	kom.	Spojnica za profil	alu AL1407	kom.
					
Metalna kvačica	alu AL2513	kom.	Podloška 14x14 mm	AL0310	kom.
					
Klizač za kotačićem	sivi AL2512	kom.	Vijak i tipla 6 mm	Z224	kom.
					vijak 6 mm
				Z53	kom.
					tipla 6 mm
Oсни klizač	AL2501	kom.			
					
Završni čep	bijeli AL0483	kom.			
	alu AL0483	kom.			
Stropni nosač	AL1408K	kom.			
					
Špaga Ø 6 mm	AL2104	met.			
					
Završna kapa	AL1405	par.			
					

Molimo vas da prilikom naručivanja komponentni **OBVEZNO** navedete šifru artikla kako bi se izbjegle eventualne pogreške!

Montaža

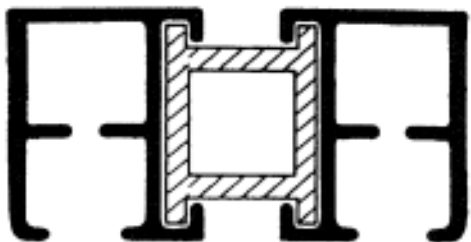

Stropna montaža

sa stropnim nosačem AL1408K

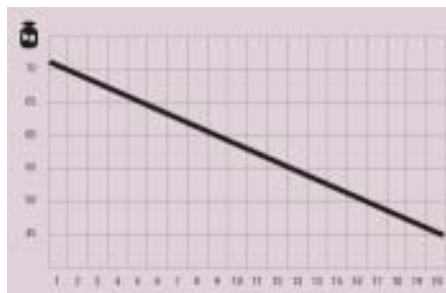

Tablica opterećenja

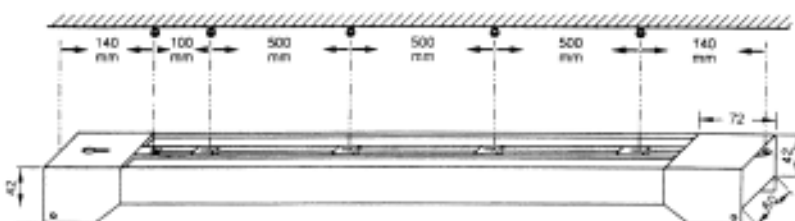

Montaža:

1.na stropu označiti liniju montaže.Pričvršćivati vijcima na cca 0,5 cm,prema razmacima navedenim u skici dimenzija.

2.Vodilicu sa stropnim držačima montirati na vijke i pričvrstiti ih.

Napomena: razlike u dimenzijama nisu bitne za razmake vijaka ili stropnih držača.Stropni držači su u vodilicama i stoga se mogu povući u željeni položaj.

Opcije otvaranja zavjese ili dekora

1 x 1



1 x 2



1 x 2 asimetrično

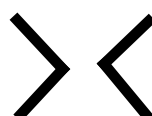

3 x 1

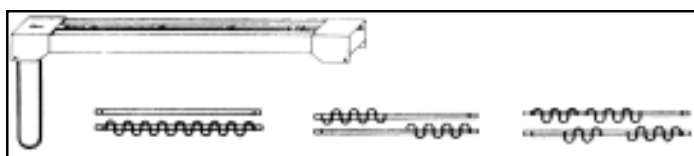

1 x jednostruka zavjesa
Druga vodilica može se iskoristiti za drugu zavjesu bez mehanizma za potezanje

1 x dvostruka zavjesa sa preklpom

2 x dvostruka zavjesa sa preklpom

AL 1700

AV 06.05

- aluminijska vodilica sa elektro mehanizmom za potezanje
- za vrlo teške dekore i zavjese
- idealno rješenje za vrlo široke otvore
- moguća upotreba i s lančićem za potezanje



...jer o tome mnogo ovisi...

SCHWOLLER-LUČIĆ

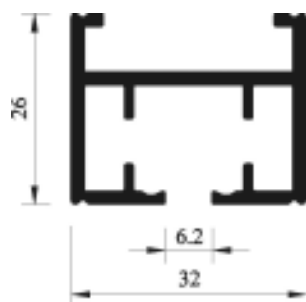

Primjena: alum.vodilica na elektropogon ili sa mehanizmom s lančićem za opremanje stanova ili većih objekata, vrlo čvrsta i prilagodljiva transportna traka, vodilica zauzima vrlo mali prostor (32x26 mm) idealno rješenje za vrlo teške dekore i zavjese, mogućnost montaže na zid ili strop

Standardne boje: alu eloksirana, bijela

Tablica s dopuštenim opterećenjima na stranici 06.10 !

Dužina [cm]	Broj klizača s kotačićem AL7472	Broj stropnih nosača AL1710
200	20	3
220	22	3
240	24	3
260	26	4
280	28	4
300	30	5
320	32	5
340	34	5
360	36	6
380	38	6
400	40	7
420	42	7
440	44	7
460	46	8
480	48	8
500	50	8
520	52	9
540	54	9
560	56	9
580	58	9
600	60	9
620	62	10
640	64	10
660	66	10
680	68	10
700	70	10

svakih slijedećih 20 cm

AL1700 sa elektromotorom brzina otvaranja 120 mm/sec	
Motor 30 W AL1730 sa prijenosnim mehanizmom i zavr.kapom	Motor 45 W AL1745 sa prijenosnim mehanizmom i zavr.kapom
cjenik za kompletnu garnituru Montaža: na strop	
Pribor: klizač s kotačićem AL7472 metalne kvačice AL2513 mehanizam za puzanje lijevi/desni AL1712/AL1713 traka s rupicama AL1716 stropni nosači AL1710 daljinski AL1762 držač za daljinski AL1763 vijci Z224 i tiple Z53	

















Broj klizača s kotačićem AL7472	Broj stropnih nosača AL1710
20	3
22	3
24	3
26	4
28	4
30	5
32	5
34	5
36	6
38	6
40	7
42	7
44	7
46	8
48	8
50	8
52	9
54	9
56	9
58	9
60	9
62	10
64	10
66	10
68	10
70	10

svakih slijedećih 20 cm

AL1700 sa lančićem za puzanje	
cjenik za kompletnu garnituru Montaža: na strop	
Pribor: klizač s kotačićem AL7472 metalne kvačice AL2513 mehanizam za puzanje lijevi/desni AL1712/AL1713 prijenosni meh. AL1714 završna kapa AL1715 traka s rupicama AL1716 ručni mehanizam s lančićem AL1720 stropni nosači AL1710 vijci Z224 i tiple Z53	

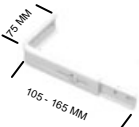

Komponente za aluminijsku vodilicu AL1700

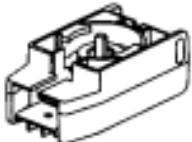
Opis artikla	Šifra artikla	Jed.mj.	Opis artikla	Šifra artikla	Jed.mj.
Vodilica AL1700 	alu AL1700	met.	Završna kapa 	AL1715	kom.
	bijela AL1700	met.			
U KOMADU (6 met.)	maksimalna dužina vodilice - 6 met.				
Vodilica AL1700 	alu AL1700A	met.	Traka s rupicama 	crna AL1716	met.
	bijela AL1700A	met.			
REZANA	maksimalna dužina vodilice - 6 met.				
Klizač za kotačićem 	sivi AL7472	kom.	Elektromotor 	30 Watt AL1730	kom.
			45 Watt AL1745		kom.
			Komplet sadrži prijenosni mehanizam i završnu kapu		
Metalna kvačica 	alu AL2513	kom.	Vijak i tipla 6 mm 	Z224	kom.
					vijak 6 mm
				Z53	kom.
					tipla 6 mm
Klizač za kotačićem 	sivi AL2512	kom.	Daljinski upravljač 	AL1762	kom.
Spojnicica profila 	siva AL1711	kom.	Držač za daljinski s kontrolama 	AL1763	kom.
Stropni nosač 	alu AL1710	kom.	Prekidač za ručno upravljanje 	AL1721	kom.
Zidni nosač - pomični 	AL1250K	kom.	Mehanizam za ručno upravljanje 	bijeli AL1720	kom.
				alu AL1720	kom.
Mehanizam za potezanje 	desni AL1712	kom.	Komplet sadrži lančić ukupne dužine 4 met.		
	lijevi AL1713	kom.			
Prijenosni mehanizam 	AL1714	kom.			

Molimo vas da prilikom naručivanja komponentni **OBVEZNO** navedete šifru artikla kako bi se izbjegle eventualne pogreške!

CJENIK VODILICE AL 1700 POD KUTEM ILI SAVIJENE

Prilikom naručivanja potrebno je priložiti i skicu ili šablonu!!

	Opis artikla	Šifra artikla
 Naručeni polumjer	Savijanje u željeni luk	AL5001

Montaža

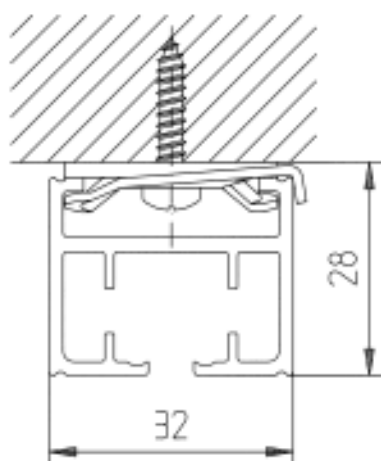

Stropna montaža

sa stropnim nosačem AL1710

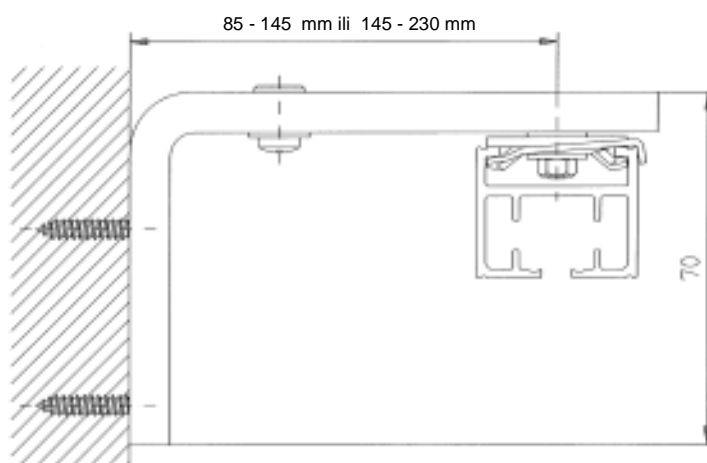

Zidna montaža

sa pomičnim zidnim nosačem AL1250K



Opcija montaže

zavjese ili dekora

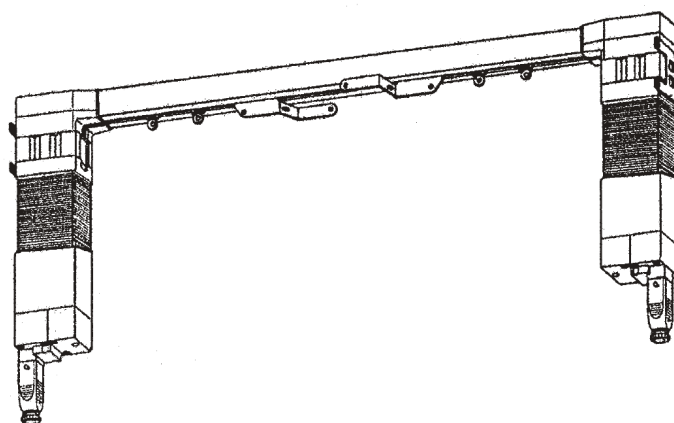
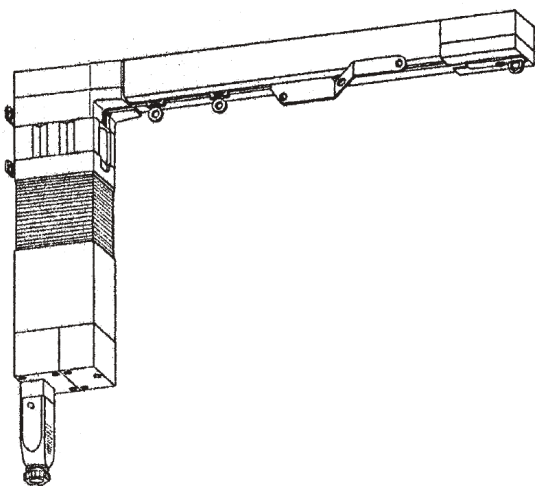
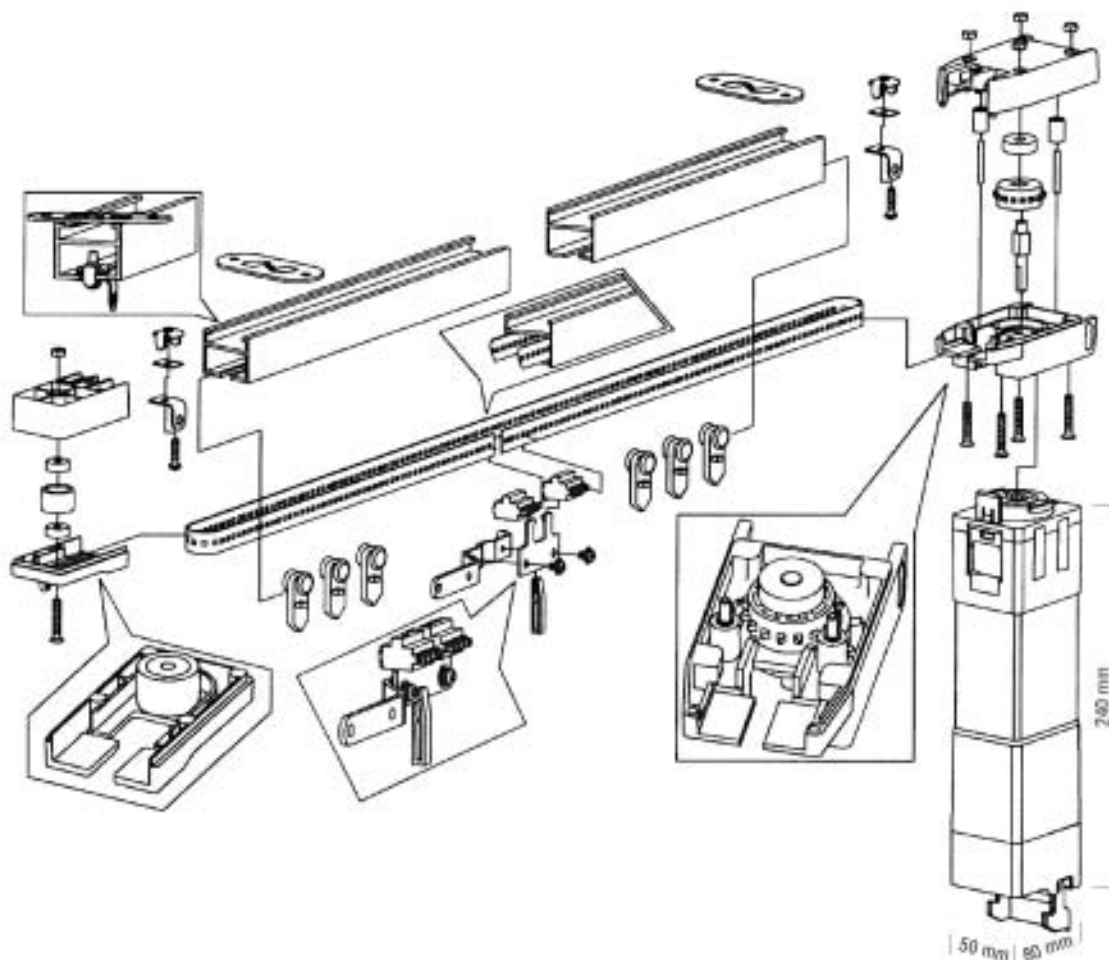

KOMPLET S JEDNIM ELEKTROMOTOROM

KOMPLET S DVA ELEKTROMOTORA

Tehničke specifikacije	jedan 30 W elektromotor	dva 30 W elektromotora	jedan 45 W elektromotor	dva 45 W elektromotora
Napajanje	230 V	230 V	230 V	230 V
Snaga	30 W	30 W	45 W	45 W
Frekvencija	50 Hz	50 Hz	50 Hz	50 Hz
Brzina povlačenja	0,12 m/sek	0,12 m/sek	0,12 m/sek	0,12 m/sek
Okretni moment	0,8 Nm	0,8 Nm	1,2 Nm	1,2 Nm



Osnovni podaci:

Maksimalna visina zavjese 6 m

Maksimalno nabiranje s Faktorom 2

Olovna vrpca 120 g / m

Težina materijala maksimalno 500 g / m²

Svinuta konstrukcija: širina konstrukcije = dužina razvučene vodilice

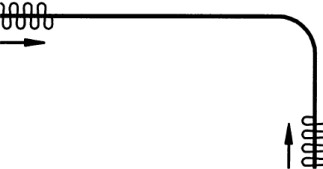
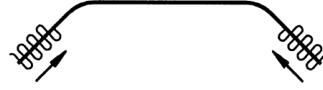
Izvedba konstrukcije	Tip motora	Širina konstrukcije (vrijednosti u kg)											
		1 m	2 m	3 m	4 m	5 m	6 m	7 m	8 m	9 m	11 m	13 m	14 m
	30 W	35	30	25	20	15	10						
	45 W	60	60	55	50	43	38	33					
	30 WT	90	90	90	90	80	70	60	50	40	30	20	
	45 WT	90	90	90	90	90	90	90	90	90	90	90	80
	30 W	33	28	20	15	10							
	45 W	40	40	33	25	20	15	10					
	30 WT	85	85	85	85	85	85	65	50	35	20		
	45 WT	90	90	90	90	90	90	90	90	90	80	70	60
	45 W	25	20	10									
	30 WT	40	40	40	40	40	30	25	20	10			
	45 WT	90	90	90	90	90	90	90	80	70	60	45	35

Sve vrijednosti navedene u kg odnose se na dvodijelne konstrukcije. Za jednodijelne konstrukcije dodaje se 20 % na širinu, odnosno kg.

Za posebne izrade, višestruka savijanja, itd. moraju se imati u vidu eventualni odgovarajući odbici kod težina.

W.....Watt

WT.....Watt/Tandem (dva motora)



Prilikom montaže vodilica zavjesa s električnim pogonom AL 1700 mora se u obzir uzeti slijedeće:

- isporučeni stezni zapor uvijek mora biti pričvršćen na čvrstom stropu, odnosno zidnom nosaču
- razmak steznih zapora ne smije prelaziti 50 cm
- nakon što se vodilica umetne u stezni zapor, mora ga se laganim okretanjem pritiskati na vodilicu

Pozor !

- konstrukcije preko 600 cm dužine dijele se i spajaju profilnom spojkom
 - uvijek se treba paziti da prijelazna kolica budu pritisnuta i fiksirana sa sigurnosnom sponom
 - motor postavite u utor i okrenite ga tako da sigurnosni zapor bude okrenut prema vodilici
- VAŽNO: SIGURNOSNI ZAPOR MOTORA OBAVEZNO FIKSIRATI. OPASNOST OD NEZGODE !**
- pri montaži uvijek pazite na oznake na motoru i konstrukciji
 - priključak na električno napajanje smije izvoditi samo stručna osoba

Montaža

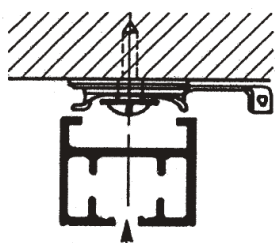

Stropna montaža sa steznim zaporom. Savitljivo do promjera 350 mm

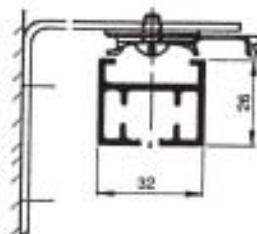

Zidna montaža s kutnicama za montažu i steznim zaporom. Savitljivo do promjera 350 mm

Elektro pogon

Ručni pogon (povlačenje s lančićem)

