

ALUMINIJSKE VODILICE SA MEHANIZMOM ZA POTEZANJE



AL 845

AV 05.01

- okrugla aluminijska vodilica sa mehanizmom za potezanje
- velika nosivost (za teške dekore i zavjese)
- mogućnost montaže na zid ili strop



...jer o tome mnogo ovisi...
SCHWOLLER-L U Č I Ć

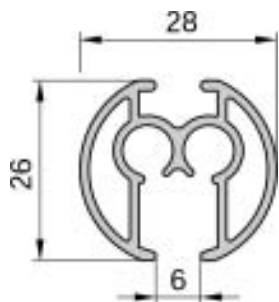

Molimo vas da prilikom naručivanja navedete visinu zavjese, položaj mehanizma (lijevo,desno) i dužinu špage za potezanje

Primjena: okrugla aluminijska vodilica sa mehanizmom za potezanje, za zidnu i stropnu montažu, lagana montaža i uporaba, velika nosivost, mogućnost naručivanja špage za potezanje u željenoj dužini



Standardne boje: alu eloksirana, bijela, imit.mesing

<p>Montaža: na strop - 1 vod.</p> <p>Pribor: osni klizač AL2501 klizač "šestica" AL2502 završni čep AL2504 uteg za špagu AL2401 mehanizam za potezanje AL7811 klizač za špagu AL7815 špaga za potezanje AL7834 završne kape AL7818 stropni nosači 1 vod. AL0487K vijci Z224 i tiple Z53</p>	<p>Montaža: na zid - 1 vod.</p> <p>Pribor: osni klizač AL2501 klizač "šestica" AL2502 završni čep AL2504 uteg za špagu AL2401 mehanizam za potezanje AL7811 klizač za špagu AL7815 špaga za potezanje AL7834 završne kape AL7818 zidni nosači 1 vod. AL2525K vijci Z224 i tiple Z53</p>
---	---

Dužina [cm]	Broj klizača	Broj nosača
100	16	2
120	20	3
140	22	3
160	26	3
180	30	3
200	32	4
220	36	4
240	38	4
260	42	4
280	46	4
300	48	5
320	52	5
340	54	5
360	58	5
380	62	5
400	64	5
420	68	5
440	70	6
460	74	6
480	78	7
500	80	7
svakih sljedećih 20 cm		
sa klizačima s kotačićem i metalnim kvačicama		

VODILICE AL 845 POD KUTEM ILI SAVIJENE











Prilikom naručivanja potrebno je priložiti i skicu ili šablonu!!





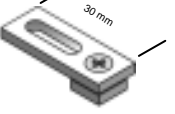
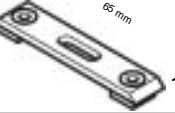



	Opis artikla	Šifra artikla
 Standard 30 cm	Standardni luk 12 cm LIJEVI	AL1002L
	Standardni luk 12 cm DESNI	AL1002D
 Naručeni polumjer	Savijanje u željeni luk	AL5005

	Opis artikla	Šifra artikla
 Radius 25 cm	Krovnna kosina 90 °	AL5006

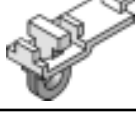

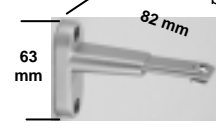
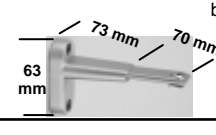
Komponente za aluminijsku vodilicu AL845

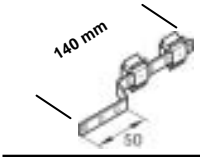
Opis artikla	Šifra artikla	Jed.mj.
Vodilica AL845	alu AL845	met.
	bijela AL845	met.
	mesing AL845	met.
U KOMADU (6 met.)	maksimalna dužina vodilice - 6 met.	
Vodilica AL845	alu AL845A	met.
	bijela AL845A	met.
	mesing AL845A	met.
REZANA	maksimalna dužina vodilice - 6 met.	
Profilna spojnica	mesing AL7337	kom.
		
Završna kapa	alu AL7941K	kom.
	bijela AL7941K	kom.
	mesing AL7941K	kom.
Oсни klizač	AL2501	kom.
		
Klizač - " šestica "	AL2502	kom.
		
Stropni nosač 1 vod.	alu AL0487K	kom.
	bijeli AL0487K	kom.
Stropni nosač 2 vod.	alu AL0488K	kom.
	bijeli AL0488K	kom.
Špaga za potezanje	bijela AL7834	met.
		
Klizač za špagu	AL7815	kom.
		
Završne kape	alu AL7818	par.
	bijeli AL7818	par.
	mesing AL7818	par.

Opis artikla	Šifra artikla	Jed.mj.
Klizač s kotačićem	AL7802	kom.
		
Metalna kvačica	alu AL2513	kom.
		
Završni čep	AL2504	kom.
		
Završni čep	AL3896	kom.
		
Zidni nosač 1 vod.	alu AL2525K	kom.
	bijeli AL2525K	kom.
	82 mm	
	63 mm	
Zidni nosač 2 vod.	alu AL2511K	kom.
	bijeli AL2511K	kom.
	73 mm	
	70 mm	
	63 mm	
Uteg za špagu	AL2401	kom.
		
Mehanizam za potezanje	AL7811	kom.
		
Vijak i tipla 6 mm	Z224	kom.
		vijak 6 mm
	Z53	kom.
		tipla 6 mm
Zatezač špaga	alu AL7890	kom.
		
	100 mm	

Molimo vas da prilikom naručivanja komponentni **OBVEZNO** navedete šifru artikla kako bi se izbjegle eventualne pogreške!

Montaža

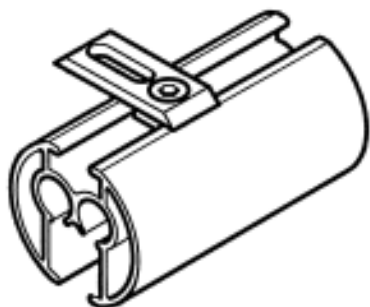

Stropna montaža 1 vod.
sa nosačem AL0487K

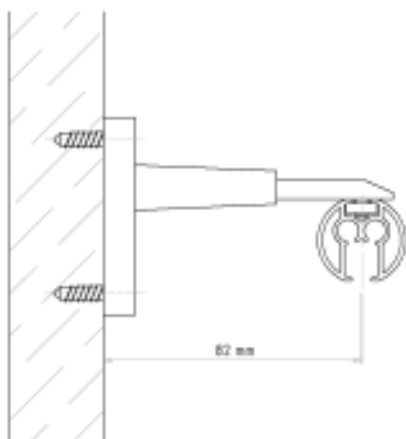

Zidna montaža 1 vod.
sa nosačem AL2525K

AL 820

AV 05.05

- visoko profilna aluminijska vodilica sa mehanizmom za potezanje
- velika nosivost (za teške dekore i zavjese)
- mogućnost montaže na zid ili strop



...jer o tome mnogo ovisi...

SCHWOLLER-L U Č I Ć

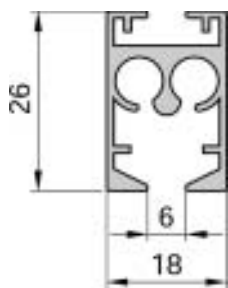

Primjena: visoko profilna aluminijska vodilica sa mehanizmom za potezanje, za zidnu i stropnu montažu, široki kanal za špagu, lagana montaža i uporaba, velika nosivost, mogućnost naručivanja špage za potezanje u željenoj dužini

Standardne boje: alu eloksirana, bijela, imit.mesing



Molimo vas da prilikom naručivanja navedete visinu zavjese, položaj mehanizma (lijevo,desno) i dužinu špage za potezanje

<p>Montaža: na strop - 1 vod.</p> <p>Pribor: osni klizač AL2501 klizač "šestica" AL2502 završni čep AL2504 uteg za špagu AL2401 mehanizam za potezanje AL7811 klizač za špagu AL7815 špaga za potezanje AL7834 završne kape AL7819 stropni nosači 1 vod. AL0487K vijci Z224 i tiple Z53</p>	<p>Montaža: na zid - 1 vod.</p> <p>Pribor: osni klizač AL2501 klizač "šestica" AL2502 završni čep AL2504 uteg za špagu AL2401 mehanizam za potezanje AL7811 klizač za špagu AL7815 špaga za potezanje AL7834 završne kape AL7819 zidni nosači 1 vod. AL2525K vijci Z224 i tiple Z53</p>
---	---

Dužina [cm]	Broj klizača	Broj nosača
100	16	2
120	20	3
140	22	3
160	26	3
180	30	3
200	32	4
220	36	4
240	38	4
260	42	4
280	46	4
300	48	5
320	52	5
340	54	5
360	58	5
380	62	5
400	64	5
420	68	5
440	70	6
460	74	6
480	78	7
500	80	7
svakih sljedećih 20 cm		
sa klizačima s kotačićem i metalnim kvačicama		

VODILICE AL 820 POD KUTEM ILI SAVIJENE













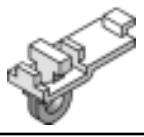
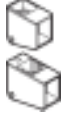

Prilikom naručivanja potrebno je priložiti i skicu ili šablonu!!

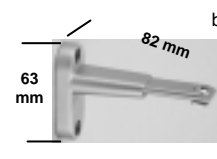
	Opis artikla	Šifra artikla
 Standard 30 cm	Standardni luk 12 cm LIJEVI	AL1002L
	Standardni luk 12 cm DESNI	AL1002D
 Naručeni polumjer	Savijanje u željeni luk	AL5005

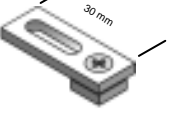
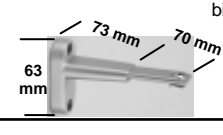
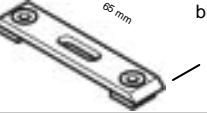
	Opis artikla	Šifra artikla
 Radius 25 cm	Krovnna kosina 90 °	AL5006

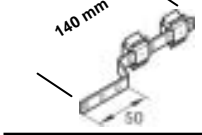

Komponente za aluminijsku vodilicu AL820

Opis artikla	Šifra artikla	Jed.mj.	Opis artikla	Šifra artikla	Jed.mj.
Vodilica AL820	alu AL820	met.	Klizač s kotačićem	AL7802	kom.
	bijela AL820	met.			
	mesing AL820	met.			
U KOMADU (6 met.)	maksimalna dužina vodilice - 6 met.				
Vodilica AL820	alu AL820A	met.	Metalna kvačica	alu AL2513	kom.
	bijela AL820A	met.			
	mesing AL820A	met.			
REZANA	maksimalna dužina vodilice - 6 met.				
Profilna spojnica	mesing AL7337	kom.	Završni čep	AL2504	kom.
					
Završne kape	alu AL7819	par.	Završni čep	AL3896	kom.
	bijela AL7819	par.			
Oсни klizač	AL2501	kom.	Zidni nosač 1 vod.	alu AL2525K	kom.
				bijeli AL2525K	kom.
Klizač - " šestica "	AL2502	kom.			
					
Stropni nosač 1 vod.	alu AL0487K	kom.	Zidni nosač 2 vod.	alu AL2511K	kom.
	bijeli AL0487K	kom.		bijeli AL2511K	kom.
Stropni nosač 2 vod.	alu AL0488K	kom.	Uteg za špagu	AL2401	kom.
	bijeli AL0488K	kom.			
Špaga za potezanje	bijela AL7834	met.	Mehanizam za potezanje	AL7811	kom.
					
Klizač za špagu	AL7815	kom.	Vijak i tipla 6 mm	Z224	kom.
					vijak 6 mm
				Z53	kom.
Zatezač špaga	alu AL7890	kom.			tipla 6 mm
					

Molimo vas da prilikom naručivanja komponentni **OBVEZNO** navedete šifru artikla kako bi se izbjegle eventualne pogreške!

Montaža

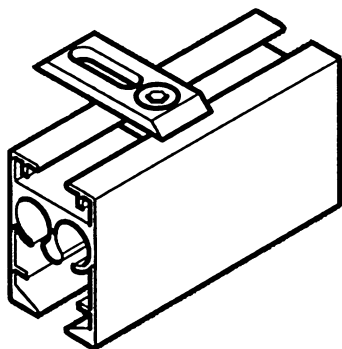

Stropna montaža 1 vod.
sa nosačem AL0487K

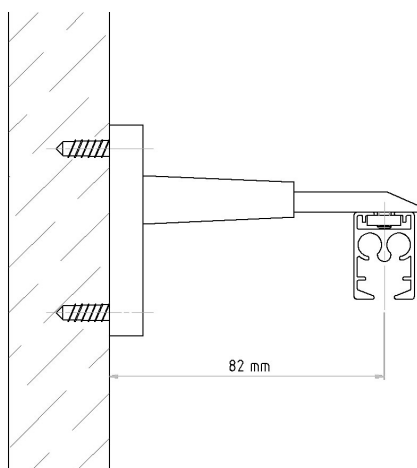

Zidna montaža 1 vod.
sa nosačem AL2525K

AL 510

AV 05.09

- **alumijska vodilica sa mehanizmom za potezanje**
- **velika nosivost (za teške dekore i zavjese)**
- **mogućnost montaže na zid ili strop**
- **mogućnost savijanja**



...jer o tome mnogo ovisi...

SCHWOLLER-LUČIĆ

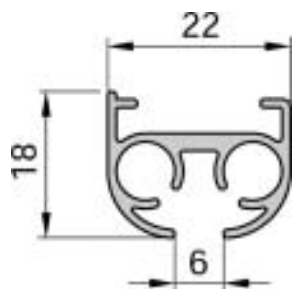

Primjena: aluminijska vodilica sa mehanizmom za potezanje, za zidnu i stropnu montažu, lagana montaža i uporaba, praktično rješenje za sve vrste savijanja, mogućnost naručivanja špage za potezanje u željenoj dužini

Standardne boje: alu eloksirana, bijela

Molimo vas da prilikom naručivanja navedete visinu zavjese, položaj mehanizma (lijevo,desno) i dužinu špage za potezanje



<p>Montaža: na strop - 1 vod.</p> <p>Pribor: osni klizač AL2501 klizač "šestica" AL2502 završni čep AL2504 uteg za špagu AL2401 mehanizam za potezanje AL7811 klizač za špagu AL7815 špaga za potezanje AL7834 završne kape AL7768 stropni nosači 1 vod. AL7607K vijci Z224 i tiple Z53</p>	<p>Montaža: na zid - 1 vod.</p> <p>Pribor: osni klizač AL2501 klizač "šestica" AL2502 završni čep AL2504 uteg za špagu AL2401 mehanizam za potezanje AL7811 klizač za špagu AL7815 špaga za potezanje AL7834 završne kape AL7768 fiksator AL2532 stropni nosači 1 vod. AL7607K zidni nosači 1 vod. AL2525K vijci Z224 i tiple Z53</p>
---	---



Dužina [cm]	Broj klizača	Broj nosača
100	16	3
120	20	3
140	22	4
160	26	4
180	30	5
200	32	5
220	36	6
240	38	6
260	42	7
280	46	7
300	48	8
320	52	8
340	54	9
360	58	9
380	62	10
400	64	10
420	68	10
440	70	11
460	74	11
480	78	12
500	80	12

svakih slijedećih 20 cm

VODILICE AL 510 POD KUTEM ILI SAVIJENE



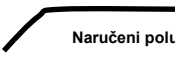







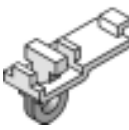

Prilikom naručivanja potrebno je priložiti i skicu ili šablonu!!

	Opis artikla	Šifra artikla
 Standard 30 cm	Standardni luk 12 cm LIJEVI	AL1002L
	Standardni luk 12 cm DESNI	AL1002D
 Naručeni polumjer	Savijanje u željeni luk	AL5005

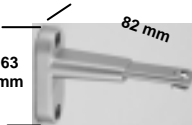
	Opis artikla	Šifra artikla
 Naručeni polumjer	Krovna kosina	AL5004
 Radius 25 cm	Krovna kosina 90 °	AL5006

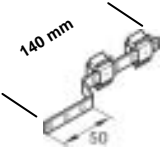

Komponente za aluminijsku vodilicu AL510

Opis artikla	Šifra artikla	Jed.mj.	Opis artikla	Šifra artikla	Jed.mj.
Vodilica AL510	alu AL510	met.	Klizač	AL2503	kom.
	bijela AL510	met.			
U KOMADU (6 met.)	maksimalna dužina vodilice - 6 met.				
Vodilica AL510	alu AL510A	met.	Stropni nosač	alu AL7607K	kom.
	bijela AL510A	met.			
REZANA	maksimalna dužina vodilice - 6 met.				
Profilna spojnica	bijela AL7792	kom.	Završni čep	AL2504	kom.
					
Završne kape	alu AL7768	par.	Fiksator	alu AL2532	kom.
	bijela AL7768	par.			
Osni klizač	AL2501	kom.	Zidni nosač 1 vod.	alu AL2525K	kom.
				bijeli AL2525K	kom.
Klizač - " šestica "	AL2502	kom.			
					
Špaga za potezanje	bijela AL7834	kom.	Uteg za špagu	AL2401	kom.
					
Klizač za špagu	AL7815	kom.	Mehanizam za potezanje	AL7811	kom.
					
Zatezač špaga	alu AL7890	met.	Vijak i tipla 6 mm	Z224	kom.
					vijak 6 mm
				Z53	kom.
					tipla 6 mm

Molimo vas da prilikom naručivanja komponentni **OBVEZNO** navedete šifru artikla kako bi se izbjegle eventualne pogreške!



Montaža

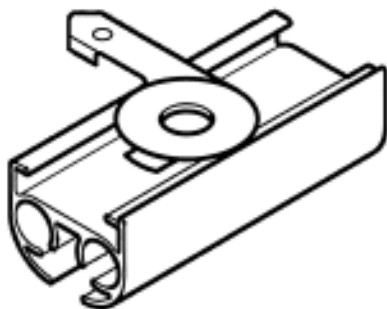

Stropna montaža 1 vod.
sa nosačem AL7607K

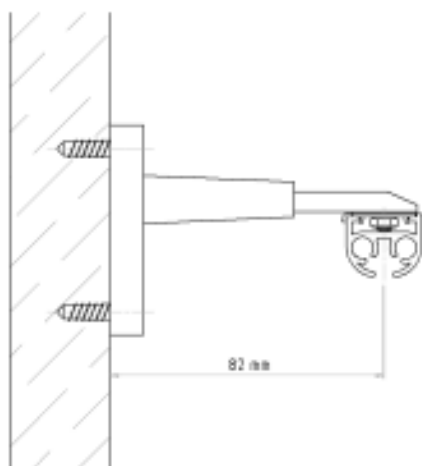

Zidna montaža 1 vod.
sa nosačem AL2525K

AL 700

AV 05.13

- **alumijska vodilica sa mehanizmom za potezanje**
- **idealna za kose prozore i prozore s kosim otvaranjem krila**
- **za lagane dekore i zavjese**
- **mogućnost montaže na strop**



...jer o tome mnogo ovisi...

SCHWOLLER-LUČIĆ

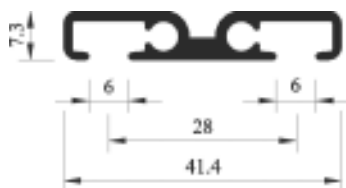

Primjena:

aluminijska vodilica sa mehanizmom za potezanje, za stropnu montažu na sve vrste stropova, lagana montaža i uporaba, praktično rješenje za kose prozore i prozore s kosim otvaranjem krila, upotreba samo za lagane dekore i zavjese, mogućnost naručivanja špage za potezanje u željenoj dužini

Standardne boje: alu eloksirana, bijela

Molimo vas da prilikom naručivanja navedete visinu zavjese, položaj mehanizma (lijevo,desno) i dužinu špage za potezanje

<p>Montaža: na strop - 2 vod. bez mehanizma za potezanje</p> <p>Pribor: osni klizač AL2501 klizač - "šestica" AL2502 završni čep AL2504 vijci Z224 i tiple Z53</p>	<p>Montaža: na strop - 1 vod. sa mehanizmom za potezanje</p> <p>Pribor: osni klizač AL2501 klizač - "šestica" AL2502 završni čep AL2504 klizač za mehanizam AL0606 mehanizam za potezanje AL2538 špage za potezanje AL2102 uteg za špagu AL2401 vijci Z224 i tiple Z53</p>
--	--

Dužina [cm]	Broj klizača	Vijci,tiple	Broj klizača
100	32	2	16
120	40	2	20
140	44	2	22
160	52	3	26
180	60	3	30
200	64	4	32
220	72	4	36
240	76	4	38
260	84	5	42
280	92	5	46
300	96	6	48
320	104	6	52
340	108	6	54
360	116	7	58
380	124	7	62
400	128	8	64
420	136	8	68
440	140	8	70
460	148	9	74
480	156	9	78
500	160	10	80
svakih slijedećih 20 cm			











CJENIK VODILICE AL 700 POD KUTEM ILI SAVIJENE

Prilikom naručivanja potrebno je priložiti i skicu ili šablonu!!

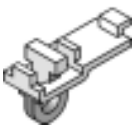
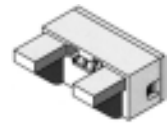
	Opis artikla	Šifra artikla
	Krovna kosina	AL5004



Komponente za aluminijsku vodilicu AL700

Opis artikla	Šifra artikla	Jed.mj.	Opis artikla	Šifra artikla	Jed.mj.
Vodilica AL700	alu AL700	met.	Klizač	AL2503	kom.
 bijela	AL700	met.			
U KOMADU (6 met.)	maksimalna dužina vodilice				
Vodilica AL700	alu AL700A	met.	Mehanizam za potezanje	AL2538	kom.
 bijela	AL700A	met.			
REZANA	maksimalna dužina vodilice - 6 met.				
Klizač za mehanizam	bijeli AL0606	kom.	Završni čep	AL2504	kom.
					
Završne kape	bijele AL0705	par.	Uteg za špagu	AL2401	kom.
					
Osni klizač	AL2501	kom.	Vijak i tipla 6 mm	Z224	kom.
					vijak 6 mm
Klizač - " šestica "	AL2502	kom.		Z53	kom.
					tipla 6 mm
Špaga za potezanje	bijela AL7834	kom.			
					

Molimo vas da prilikom naručivanja komponentni **OBVEZNO** navedete šifru artikla kako bi se izbjegle eventualne pogreške!

Montaža



Stropna montaža 1 vod.